

Optimum Components & Precision Dispense Tips

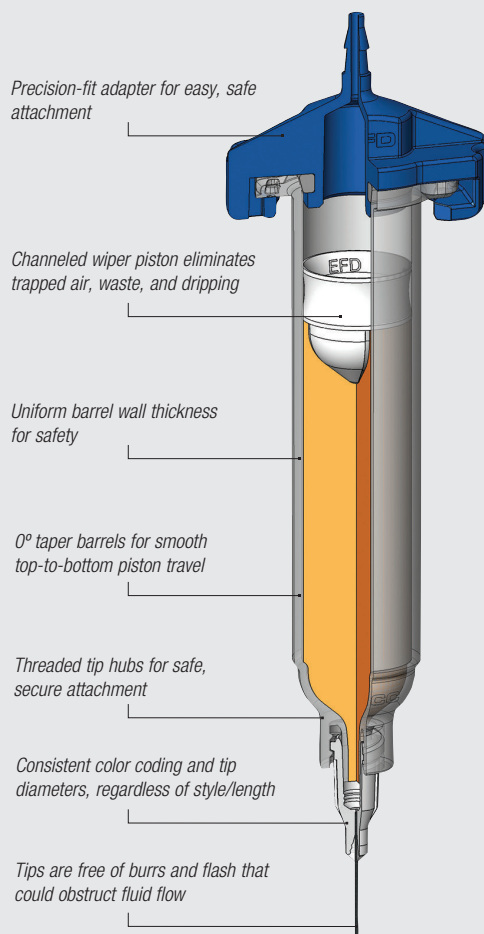

The Standard in Fluid Dispensing

What makes EFD's Optimum dispensing components better than the rest? Engineered Fluid Dispensing™.

Each patented component has been designed as part of a complete, integrated system that improves yields and reduces costs by producing the most accurate, repeatable fluid deposits possible.

Our syringe barrels are made of a proprietary polypropylene blend that delivers exceptional clarity and dimensional stability. The unique internal design enhances fluid flow and minimizes turbulence and shear during filling and dispensing.

Matching pistons are available in six styles to ensure control for virtually any fluid in any application. When fluid is dispensed, the close tolerance wiping action eliminates waste and residue.

Syringe barrel adapters have a design that facilitates installation/removal, and a positive safety locking action that prevents accidental disengagement.

Free of flash, burrs, or other contaminants, EFD dispensing tips are designed with engineered hub flats for easy twist on, twist off, and SafetyLok threads to ensure safe, positive attachment to the syringe barrel.

Dispensing Components



Optimum Syringe Barrels

EFD produces the highest quality syringe barrels and pistons in the industry. Syringe barrels and pistons are produced in our own silicone-free facilities, where they are subjected to stringent quality control inspections throughout the entire manufacturing process.

Features and Benefits

- Precision fit between syringe and piston ensures consistent fluid deposits
- Wiper piston improves fluid control, keeps fluids from dripping and eliminates waste by wiping the syringe wall clean
- Wide variety of styles and sizes
- Package labels include lot numbers for process control and traceability

"One stop shopping for syringes, barrel adapters, needles and tips along with excellent reference materials and pictures of actual applications to spark new ideas."

– Infinera

SYRINGE BARREL & PISTON SETS

Each box contains syringes and pistons in dust-free packaging.

Size	MOST FLUIDS	UV/Light Block*	Opaque	QTY
	Clear Barrels White Pistons	Amber Barrels White Pistons	Black Barrels White Pistons	
3cc	7366044	7366041	7366042	(100)
5cc	7366045	—	—	(100)
10cc	7366040	7366039	—	(100)
30cc	7366054	7366051	7366052	(50)
55cc	7366056	7366055	—	(50)

Sets are available in clear for most fluids; transparent amber for UV- and light-sensitive materials (less than 12% visible light from 550 nm or less); and opaque black for complete light blockage.

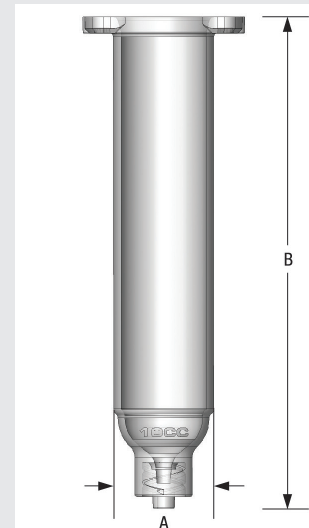

SYRINGE BARRELS

Each box contains syringes and pistons in dust-free packaging.

Size	MOST FLUIDS	UV/Light Block*	Opaque	QTY
	Clear Barrels	Amber Barrels	Black Barrels	
3cc	7366095	7366092	7366093	(100)
5cc	7366101	7366098	7366099	(100)
10cc	7366089	7366086	7366087	(100)
30cc	7366060	7366057	7366058	(50)
55cc	7366066	7366063	7366064	(50)
70cc	7366070	7366069	—	(50)

Note: 30cc, 55cc, and 70cc syringe barrels accept the same size barrel pistons, end caps, and adapters. Order pistons separately.

*Transparent amber for UV- and light-sensitive materials (less than 12% visible light from 550 nm or less); and opaque black for complete light blockage.

BARREL DIMENSIONS

Size	A	B
3cc	11.1 mm (0.44")	73.0 mm (2.88")
5cc	14.3 mm (0.56")	68.3 mm (2.69")
10cc	19.1 mm (0.75")	88.9 mm (3.50")
30cc	25.4 mm (1.0")	115.9 mm (4.56")
55cc	25.4 mm (1.0")	173.0 mm (6.81")
70cc	25.4 mm (1.0")	213.1 mm (8.39")

Note: This data is typical and does not constitute a specification.



www.nordsonefd.com/1kOptimum

Dispensing Components

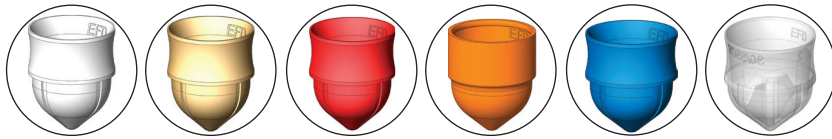

A piston is inserted into the syringe barrel after it has been loaded with fluid to ensure uniform dispensing, prevent dripping, and eliminate waste by wiping barrel walls clean as fluid is dispensed. Optimum pistons are molded from high-density polyethylene.*

SYRINGE BARREL PISTONS

Size	White SmoothFlow	Beige SmoothFlow	Red SmoothFlow	Orange Flatwall	Blue LV Barrier	Clear Flex	QTY
3cc	7366134	7366126	7366133	7366132	7366128	7366131	(100)
5cc	7366141	7366135	7366140	7366139	n/a	7366138	(100)
10cc	7366125	7366117	7366124	7366123	7366119	7366122	(100)
30/55/70cc	7366084	7366076	7366083	7366082	7366078	7366081	(50)

*Clear Flex pistons are molded from LDPE (low-density polyethylene).

Optimum Pistons

Available in six styles:

White SmoothFlow wiper pistons are used with most fluids.

Beige SmoothFlow pistons are loose-fitting and used with air-entrapped fluids.

Red SmoothFlow pistons are tight-fitting and used with mechanical dispensers.

Orange Flat-walled pistons have a looser fit to prevent "bouncing" when dispensing stringy, air-entrapped fluids.

Blue LV Barrier pistons are for cyanoacrylates and very low viscosity fluids.

Clear Flex pistons are flexible and reduce "bouncing" in viscous fluids while maintaining excellent wall-wiping.



End caps and tip caps provide an airtight seal that allows you to prefill syringe barrels or seal partially used syringes between shifts.

End caps feature a precision fit and use a convenient push-button to produce a snug, air-tight seal.

Tip caps have a large knurled gripping surface that simplifies attachment, and a vent that prevents air from being introduced into the syringe barrel during installation. The gripping action of the tip cap is designed to maximize the seal and yet be easily removed by the user. Available in blue or green.

Optimum End and Tip Caps

SNAP-TIGHT END AND TIP CAPS

Snap-on end caps provide tight seal.

Size	Blue	Green	QTY
3cc	7366108	7366111	(100)
5cc	7366113	7366116	(100)
10cc	7366104	7366107	(100)
30/55/70cc	7366071	7366074	(50)

Twist-on tip cap seals syringe barrel.

One size	Blue	QTY	Green	QTY
	7012198	(50)	7362541	(1000)

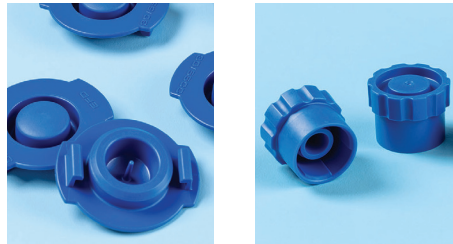

Lightweight adapters are designed for fast attachment and feature slots that lock securely onto matching tabs on the syringe barrel.

ADAPTER ASSEMBLIES

Size	Blue 0.9 m (3 ft) Hose	Blue 1.8 m (6 ft) Hose	Blue 0.9 m (3 ft) Hose w/ filter trap	Quicksilver 1.8 m (6 ft) Hose
3cc	7012341	7012059	7012063	7364491
5cc	7012054	7012058	7012062	7364490
10cc	7012339	7012057	7012061	7364489
30/55/70cc	7012338	7012056	7012060	7364488

Blue molded one-piece, acetal adapter head with NBR O-ring, flexible polyurethane air hose (5/32" OD X 3/32" ID), male quick-connect, and safety clip. For general use. Quicksilver for use with UltimiusPlus dispensers. See next page for Unity adapters.

Adapter Assemblies

Dispensing Components

Nordson EFD Optimum Class VI grade syringe barrels are made from biocompatible materials that meet the requirements for United States Pharmacopeia (USP) Class VI resin.

Features and Benefits

- Enhanced biocompatibility for medical use
- Ease of process validation for regulatory approvals
- Market-leading traceability for documentation requirements
- Ability to sterilize to ensure a bacteria-free product

CLASS VI COMPONENTS				
Size	Class VI Clear Barrels	Class VI Clear Pistons	Class VI Clear End Caps	Qty/Box
3cc	7366097	7366130	7366110	100
5cc	7366103	7366137	7366115	100
10cc	7366091	7366121	7366106	100
30cc	7366062	7366080	7366073	50
55cc	7366068	7366080	7366073	50
CLASS VI TIP CAPS				
7364590				50

Optimum Class VI pistons are designed for use with Class VI barrels only.

Optimum Class VI Components



Nordson EFD's Optimum ECO dispensing components are manufactured from sustainably-sourced polyethylene and feature a bio-based content rating of 94% to 96%. This eco-friendly system helps meet corporate sustainability initiatives by using raw resins derived from sugarcane stock versus byproducts of the petrochemical industry.

Features and Benefits

- Eco-friendly components are made from renewable resources
- Minimize consumption and greenhouse gases, reducing carbon footprint
- Barrel transparency allows operator to see fluid level
- Superior freezing properties for premixed fluids compared to standard polypropylene barrels

ECO COMPONENTS				
Size	ECO Natural Barrels	ECO Natural Pistons	ECO Natural End Caps	Qty/Box
3cc	7366096	7366129	7366109	100
5cc	7366102	7366136	7366114	100
10cc	7366090	7366120	7366105	100
30cc	7366061	7366079	7366072	50
55cc	7366067	7366079	7366072	50
ECO TIP CAPS				
7364679				50

Optimum ECO pistons are designed for use with ECO barrels only.

Optimum ECO Components



Dispensing Components

Nordson EFD's disposable Unity™ HiTemp™ syringe barrels provide a cost-effective alternative to syringes commonly used in pneumatic dispensing of hot melt adhesives. The barrels are compatible with Nordson's Unity IC Series and Unity PURJet™ 30 dispensing systems and other standard industry hot melt dispensers.

Features and Benefits

- Proprietary materials maintain integrity at high temperatures for up to eight hours
- Disposability reduces downtime and maintenance costs with better cost of ownership compared to standard metal syringes
- Reliable, repeatable hot melt adhesive dispensing at up to 180° C

Unity HiTemp Components



UNITY COMPONENTS						
Size	Syringe Barrels		Tip Cap White Extreme HiTemp	Adapter Assembly 3ft Tubing	Adapter Assembly 6ft Tubing	Qty/ Box
	HiTemp (125° C)	Extreme HiTemp (180° C)				
30cc	7360475	7360473	7360452	7362348*	7362347*	20

*Adapter assemblies sold individually.

Dial-A-Dose Industrial Syringes

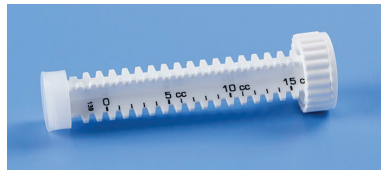

Dial-A-Dose plunger



One-piece plunger

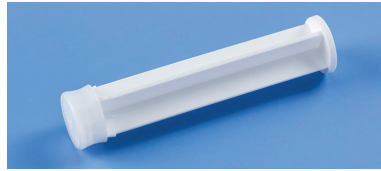

Two-piece plunger

Dial-A-Dose Industrial Syringes

For use with:

Adhesives

Epoxies & Silver Epoxies

Greases & Lubricants

Sealants

Solder Pastes

Nordson EFD offers a comprehensive selection of syringes used for fluid packagers in the electronics rework, industrial, dental, and do-it-yourself markets. Dial-A-Dose® syringes are an ideal packaging system for controlled placement of adhesives and sealants. For multi deposit use, EFD Dial-A-Dose syringes offer an innovative, customizable solution to tailor deposits based on application size and other requirements.

Features and Benefits

- Range of sizes, colors, and nozzles
- Self-venting barrels with “lead-in” aid for easy fill
- Single and multi deposit syringes allow manufacturers to make the deposit, cap the syringe, and save for next deposit
- Locking ring ensures exact amount is dispensed

DIAL-A-DOSE INDUSTRIAL SYRINGES

Syringes include integrated molded nozzle. Order plungers and caps separately. White caps molded in LDPE.

Syringe	Size	Material	Color	Cap	Multi-Dose Plunger	Single-Dose Plunger Options	
					Dial-A-Dose	One-Piece	Two-Piece
Nozzle Style: Short Taper 1/16" ID x 7/32" Length							
7660308	15cc	PE	White	7660192	7660343	7660329	7660333
Nozzle Style: Thin Taper 1/16" ID x 1-1/18" Length							
7660277	6cc	PE	White	7660194	—	7660292	—
7022846	15cc	PE	White	7660194	7660343	7660329	7660333
7026529	30cc	PE	White	7660194	—	7660380	—
Nozzle Style: Luer Lock 1/16" ID x 1/4" Length							
7660228	3cc	PP	Clear	7660246	—	7660263	—
7660392	32cc	PP	Amber	7660246	7660452	7660427	7660436

Continued next page

Dial-A-Dose Syringes

From previous page

DIAL-A-DOSE INDUSTRIAL SYRINGES							
Syringe	Size	Material	Color	Cap	Multi-Dose Plunger	Single-Dose Plunger Options	
					Dial-A-Dose	One-Piece	Two-Piece
Nozzle Style: Standard 3/16" ID x 1-13/32" Length							
7660279	6cc	PE	White	7660198	7661311	–	–
7660313	15cc	PE	White	7660198	7660343	7660329	7660333
7660399	32cc	PE	White	7660198	7660452	7660427	7660436
7660508	60cc	PE	White	7660198	7660538	–	7660528
7660571	100cc	PP	Clear	7660198	7660580	–	7660581
Nozzle Style: Luer Slip 3/32" ID x 11/32" Length							
7660229	3cc	PE	White	7660201	–	7660263	–
Nozzle Style: Medium 9/32" ID x 1-13/32" Length							
7660419	32cc	PE	White	7660207	7660452	7660427	7660436
7660482	34cc	PE	White	7660207	7660452	7660427	7660436
Nozzle Style: Cone 3/32" ID x 1-1/2" Length							
7660371	30cc	PE	White	7660201	–	7660380	–
Nozzle Style: Medium 1/4" ID x 1-23/64" Length							
7660517	60cc	PE	White	7660207	7660538	–	7660528
7660552	80cc	PE	White	7660207	7660557	–	7660938
Nozzle Style: Wide 13/32" ID x 1-5/16" Length							
7660522	60cc	PE	White	7660191	7660538	–	7660528
7660553	80cc	PE	White	7660191	7660557	–	7660938
7660572	100cc	PE	White	7660191	7660580	–	7660581
Nozzle Style: Wide Taper 1/4" ID x 7/8" Length							
7660488	36cc	PE	White	7660210	–	–	7660492
Nozzle Style: Luer Slip Variant 1/16" ID x 21/32" Length							
7660239	3cc	PE	White	7660201	–	7660257	–

Optimum Cartridge Systems

Optimum cartridges and retainers have been designed to function as a complete, integrated system that improves yields and reduces costs in fluid packaging and dispensing processes.

Cartridge systems are designed for applications that require a reservoir larger than a 70cc syringe barrel. They are available in 2.5 fl oz, 6 fl oz, 12 fl oz, 20 fl oz, and 32 fl oz capacities, and can be used to make timed or visual deposits.



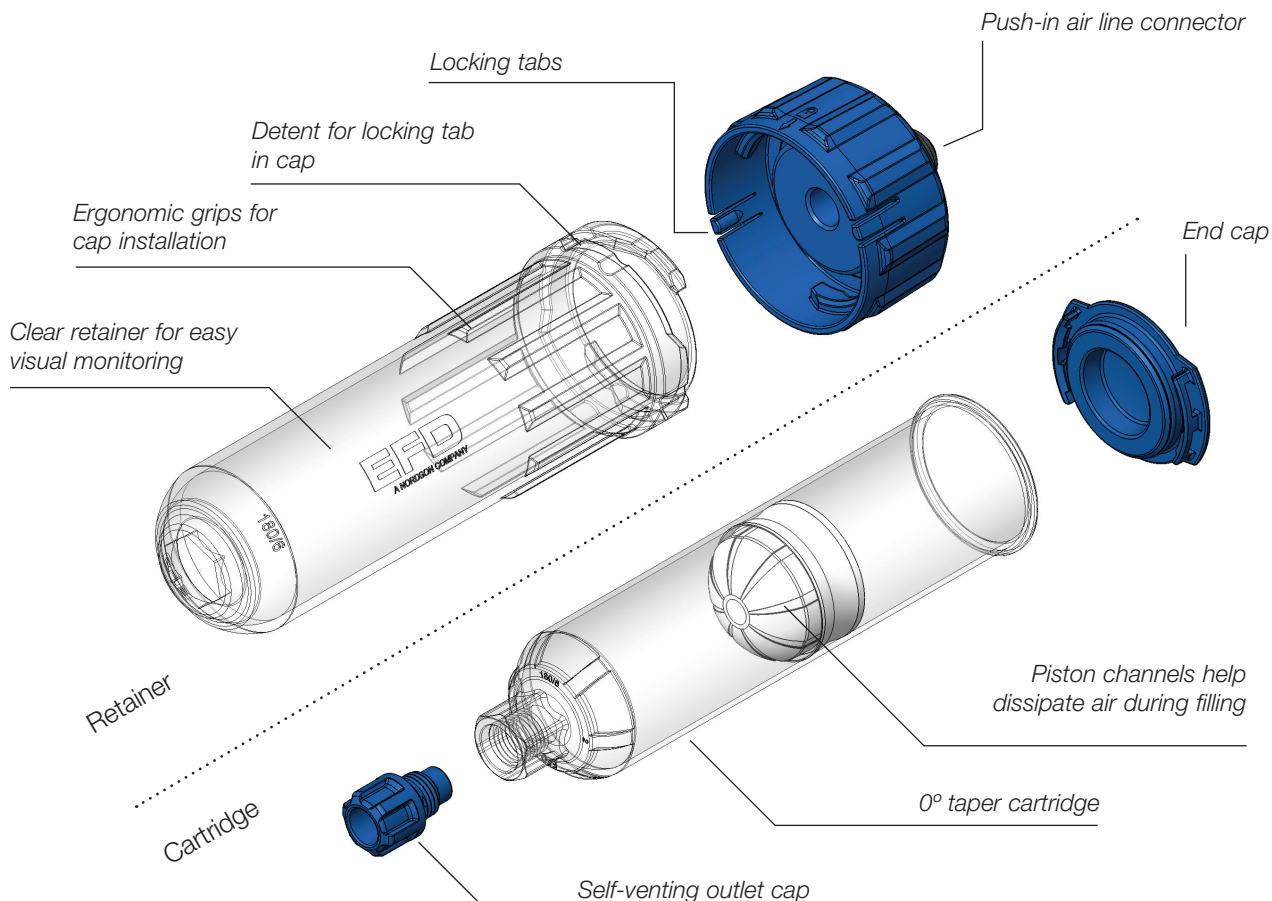

Features and Benefits



- Exceptional clarity to allow visual confirmation of fluid levels
- High-impact strength and dimensional stability
- ZeroDraft™ design ensures that internal diameter is consistent from top to bottom
- Excellent chemical compatibility with a wide range of fluids
- Available in clear, black, amber, and white
- White cartridges are molded from a proprietary blend and have better frozen temperature resistance



CARTRIDGES					
Size	Clear	White	Amber	Black	QTY
2.5 fl oz (75 ml)	7012389	n/a	7012390	—	25
6 fl oz (180 ml)	7012398	7361311	7012399	7012400	25
12 fl oz (360 ml)	7012407	7029498	7012408	7012409	25
20 fl oz (600 ml)	7012416	7028361	7012736	7013878	10
32 fl oz (960 ml)	7014088	7028392	7014089	7014091	10

Sets are available in clear for most fluids; transparent amber for UV- and light-sensitive materials (less than 12% visible light from 550 nm or less); and opaque black for complete light blockage.

CARTRIDGE FITTINGS			
For both internal molded nozzle cartridges and external threaded cartridges. For cartridge nozzles, see Precision Dispensing Tips.			
Fitting	Part #	Material	Description
	7022420	Nylon	Barrel loader fitting 90° 1/4 NPT male Female luer lock to barrel elbow
	7022415	Stainless Steel	Barrel loader fitting 1/4 NPT male Female luer lock
	7017020	Black Polypropylene	1/4 NPT x 3/8 compression
	7017014	Black Polypropylene	1/4 NPT x 1/4 compression

TIP ADAPTERS			
Adapter	Part #	Material	Description
	7016941	Polypropylene	1/4 NPT standard cartridge tip adapter
	7016945	Nickel-plated Brass	1/4 NPT special purpose tip adapter for 725D Series, 725DA Series, 725HF-SS, 736HPA-NV, and cartridges
	7016948	Black Polypropylene	1/4 NPT tip adapter

CARTRIDGE DIMENSIONS			
Size	A	B	
2.5 fl oz (75 ml)	43.2 mm (1.70")	98.8 mm	(3.89")
6 fl oz (180 ml)	43.2 mm (1.70")	181.5 mm	(7.15")
12 fl oz (360 ml)	43.2 mm (1.70")	314.3 mm	(12.38")
20 fl oz (600 ml)	68.3 mm (2.69")	249.7 mm	(9.83")
32 fl oz (960 ml)	68.3 mm (2.69")	346.4 mm	(13.69")

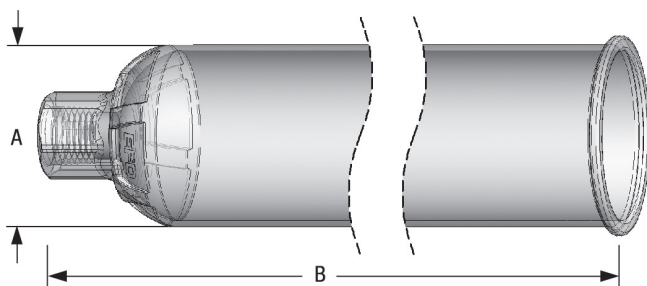

Note: This data is typical and does not constitute a specification.

Optimum Cartridge Systems



Cartridge Retainer Systems

Optimum cartridge retainers are molded from high-tensile, clarified resin that permits easy visual monitoring of fluid levels. Large textured ribs provide an ergonomic grip for cap installation.

Retainer caps feature locking tabs that snap securely into detents on the retainer body with an audible click. A push-in air line connector on top of the cap eliminates the need for bayonet connectors.

"EFD is our favorite vendor to deal with – fast, professional, and top notch products."
– Contract Packager

RETAINER SYSTEMS				
Retainer Systems*		Retainer Bodies		
Part #	Size	Part #	Size	
7012430	2.5 fl oz (75 ml)	7013857	2.5 fl oz (75 ml)	
7012433	6 fl oz (180 ml)	7013858	6 fl oz (180 ml)	
7012436	12 fl oz (360 ml)	7013859	12 fl oz (360 ml)	
7012439	20 fl oz (600 ml)	7013860	20 fl oz (600 ml)	
7013899	32 fl oz (960 ml)	7013900	32 fl oz (960 ml)	
Retainer Cap Assemblies				
Part #	Size			
7012531	2.5, 6, 12 fl oz (75, 180, 360 ml)			
7012532	20, 32 fl oz (600, 960 ml)			
Retainer Cap O-ring Kits (2/pkg.)				
Part #	Material	Size		
7014373	Buna	2.5, 6, 12 fl oz (75, 180, 360 ml)		
7026914	EPR	2.5, 6, 12 fl oz (75, 180, 360 ml)		
7014372	Buna	20, 32 fl oz (600, 960 ml)		
7026916	EPR	20, 32 fl oz (600, 960 ml)		
7026917	Viton	20, 32 fl oz (600, 960 ml)		

*Note: For retainer systems with 100 psi and 15 psi regulators, see Tanks, Reservoirs, and Pumps. The retainer cap O-rings are available in three different materials. Please select the one most compatible with your fluid. Standard O-ring material is Buna.

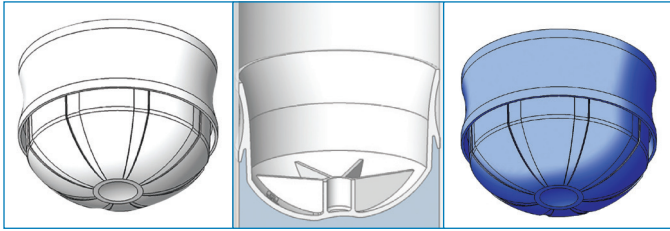

Optimum pistons are precision molded from high-density polyethylene. The consistent fit perfectly matches cartridge walls for smooth, unobstructed travel and ensures consistent results in fluid packaging and dispensing processes.

Unique channels help dissipate air during the filling process, reducing or eliminating the need to centrifuge. Dual wiping edges eliminate waste and residue to lower production costs and simplify disposal of used cartridges.

Blue pistons have a smaller leading edge wiper. The looser fit reduces dripping or stringing during the dispensing of very thick fluids and the color makes it easy to see the piston position inside the cartridge.

CARTRIDGE PISTONS			
Part #	Size	Color	Qty/Box
7012419	2.5, 6, 12 fl oz (75, 180, 360 ml)	White	25
7362087	2.5, 6, 12 fl oz (75, 180, 360 ml)	Blue	25
7012421	20, 32 fl oz (600, 960 ml)	White	10



Cartridge End/Outlet Caps

End caps snap securely over cartridge flanges to prevent leaks and fluid contamination. The center push-button presses the cap against the cartridge wall to form a positive, airtight seal.

Self-venting outlet caps feature a large ribbed gripping area that simplifies manual installation, along with precision molded threads and a tapered seat that provides a snug, leakproof seal.

CARTRIDGE END CAPS			
Part #	Size	Color	Qty/Box
7012423	2.5, 6, 12 fl oz (75, 180, 360 ml)	Blue	25
7012425	20, 32 fl oz (600, 960 ml)	Blue	10

CARTRIDGE OUTLET CAPS			
Part #	Size	Color	Qty/Box
7012427*	All	Blue	25

*Tighten to: 10 lbf-in

Precision Dispensing Tips



Optimum Dispensing Tips

EFD produces the highest quality dispensing tips in the industry. All tips are produced in our own silicone-free facilities and subjected to stringent quality control inspections throughout the entire manufacturing process.

Features and Benefits

- Free of flash, burrs, and contaminants
- Package labels include lot numbers for process control and traceability
- Consistent from style to style and lot to lot
- 360° SafetyLok™ thread ensures safe, positive attachment to syringe barrel
- Engineered hub flats for easy twist on, twist off

Available in multiple styles:

Precision Stainless Steel Passivated stainless steel tips handle a wide range of fluids and applications.

Tapered Smooth flow for application of medium- to high-viscosity fluids — especially thick or particle-filled materials like epoxies, RTVs, and braze pastes.

Flexible Polypropylene shafts reach into hard-to-access areas and will not scratch delicate surfaces. Easily cut to size or angled as needed.

Angled Stainless steel tips available with 45° and 90° bends. Custom bends available.

Brush For spreading glues and greases. Available with soft or stiff bristles.

Specialty For specific applications: Chamfered, PTFE-coated and PTFE-lined, microdot tips, and oval tips.

Ceramic MicroDot For precise micro-deposits as small as 100 µm. Compatible with wide range of fluids, even fine particle-filled materials.

Precision Nozzle For tight tolerance micro-dispensing in CCM, LED, semiconductor, and other high-precision industries.

“EFD components are more durable than others we have used. We have never encountered a problem with EFD tips and syringes, and that’s saying a lot.”

— Magnavox

DISPENSING TIP SAMPLE KIT

Part #	Description
7013229	Includes a selection of various types and styles of dispensing tips, pistons, tip and end caps — 150+ pieces



www.nordsonefd.com/TipAdvice

Precision Dispensing Tips



PRECISION STAINLESS STEEL TIPS														
Gauge	Color		ID		OD		Straight	Straight	Straight	Straight	45° Bend	90° Bend	45° Bend	Qty/ Box
			mm	inch	mm	inch	6.35 mm (0.25")	12.7 mm (0.50")	25.4 mm (1.0")	38.1 mm (1.5")	12.7 mm (0.5")	12.7 mm (0.5")	38.1 mm (1.5")	
14		Olive	1.54	0.060	1.83	0.072	7018029	7018043	7018032	7018035	7018044	7018045	7016906	50
15		Amber	1.36	0.053	1.65	0.065	–	7018068	7018059	7018062	7018069	–	n/a	50
18		Green	0.84	0.033	1.27	0.050	7018107	7018122	7018110	7018113	7018123	7018124	7016908	50
20		Pink	0.61	0.024	0.91	0.036	7018163	7018178	7018166	7018169	7018179	7018180	n/a	50
21		Purple	0.51	0.020	0.82	0.032	7005005	7018233	7018222	7018225	7018234	–	7016910	50
22		Blue	0.41	0.016	0.72	0.028	7018260	7018272	7018263	7018266	7018273	7018274	n/a	50
23		Orange	0.33	0.013	0.65	0.025	7018302	7018314	7018305	7018308	7018315	7018316	n/a	50
25		Red	0.25	0.010	0.52	0.020	7018333	7018345	7018336	7018339	7018346	7018347	n/a	50
27		Clear	0.20	0.008	0.42	0.016	7018395	7005008	n/a	n/a	7018404	7018405	n/a	50
30		Lavender	0.15	0.006	0.31	0.012	7018424	7018433	n/a	n/a	7018434	7018435	n/a	50
32		Yellow	0.10	0.004	0.24	0.009	7018462	n/a	n/a	n/a	n/a	n/a	n/a	50

Burr-free, polished, passivated stainless steel dispensing tips with polypropylene SafetyLok hubs for a secure fit to barrel reservoirs.

- 6.35 mm (0.25") tips: Fast point-to-point dispensing.
- 12.7 mm (0.50") tips: Standard all-around precision dispensing tips.
- 45° and 90° bent tips: Easy access into hard-to-reach areas.

SMOOTHFLOW TAPERED TIPS							
Gauge	Color		ID		Standard	Opaque Rigid	Qty/ Box
			mm	inch			
14		Olive	1.60	0.063	7018052	7018049	50
16		Grey	1.19	0.047	7018100	7018097	50
18		Green	0.84	0.033	7018158	7018147	50
20		Pink	0.58	0.023	7005009	7005006	50
22		Blue	0.41	0.016	7018298	7005007	50
25		Red	0.25	0.010	7018391	7018370	50
27		Clear	0.20	0.008	7018417	n/a	50



Use with gel cyanoacrylates, UV-cure adhesives, sealants, and particle-filled materials or any medium- to high-viscosity fluid. Standard, flexible translucent tips are molded of polyethylene and the colored versions contain a light-block additive that protects UV-sensitive fluids. Rigid opaque tips are molded of polypropylene and the opacity of the material delivers light-blocking functionality to protect light-sensitive fluids. Standard tapered tips are recommended for best results.

FLEXIBLE TIPS							
Gauge	Color		ID		12.7 mm (0.50")	38.1 mm (1.5")	Qty/ Box
			mm	inch			
15		Amber	1.25	0.049	7018085	7018080	50
18		Green	0.84	0.033	7018143	7018138	50
20		Pink	0.48	0.019	7018205	7018201	50
25		Red	0.36	0.014	7018366	7018362	50

Flexible polypropylene tubing for application into difficult-to-access areas. Easily drags along edges and around corners and prevents scratching. Tubing can be cut to length.

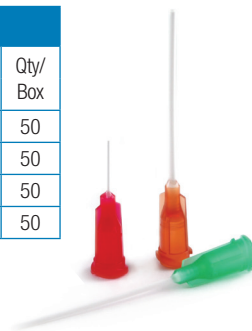





BRUSH TIPS			
Style	50.8 mm (2") length		Qty/ Box
	Standard	High Flow	
Soft bristle	7022730	7022731	50
Stiff bristle	7015351	7015467	50



Spread glues and greases. Brush tips are made with high quality 6/12 nylon, known for its strength and wear resistance. Soft brush tips are 0.003" diameter level; stiff brush tips are 0.006".



Precision Dispensing Tips







PTFE-COATED TIPS								
Gauge	Color		ID		OD		12.7 mm (0.50")	Qty/Box
			mm	inch	mm	inch		
21		Purple	0.51	0.020	0.84	0.033	7018243	20
22		Blue	0.41	0.016	0.74	0.029	7018290	20
23		Orange	0.33	0.013	0.66	0.026	7018326	20
25		Red	0.25	0.010	0.53	0.021	7018359	20

Controls wicking to stop drips in optical media applications.





PTFE-LINED TIPS						
Color	ID		12.7 mm (0.50")	25.4 mm (1.0")	Qty/Box	
	mm	inch				
	Grey	0.51	0.020	7018256	7005003	50
	Pink	0.30	0.012	7018388	7005004	50

Resists clogging of cyanoacrylates. Use for microdot application of low viscosity fluids.



CHAMFERED TIPS								
Gauge	Color		ID		38.1 mm (1.50")	12.7 mm (0.50")	6.35 mm (0.25")	Qty/Box
			mm	inch				
18		Green	0.84	0.033	n/a	7018129	n/a	50
20		Pink	0.61	0.024	7018188	n/a	n/a	50
22		Blue	0.41	0.016	7018281	n/a	n/a	50
23		Orange	0.33	0.013	n/a	7018321	n/a	50
25		Red	0.25	0.010	n/a	7018352	n/a	50
27		Clear	0.20	0.008	n/a	n/a	7015236	50
33		Clear	0.10	0.004	n/a	n/a	7018482	25

Use for microdot application of low viscosity fluids.



CERAMIC MICRODOT TIPS						
Gauge	Color		ID		Part #	Qty/Box
			mm	inch		
37		Black	0.05	0.002	7364054	1
37		Black	0.05	0.002	7364055	10
37		Silver	0.05	0.002	7364386	1
37		Silver	0.05	0.002	7364540	1

Part number 7364386 only for use with PICO contact dispense valve.





PRECISION NOZZLES					
Gauge	ID		Part # Qty: 1 pc.	Part # Qty: 10 pc.	
	mm	inch			
21	0.50	0.020	7365112	7365121	
22	0.40	0.016	7365110	7365119	
24	0.30	0.012	7365108	7365117	
25	0.25	0.010	7365107	7365116	
27	0.20	0.008	7365106	-	
30	0.15	0.006	7365105	7365114	
32	0.10	0.004	7365104	7365113	



OVAL TIPS				
Gauge	Color		12.7 mm (0.50")	Qty/Box
15		Amber	7018078	50
18		Green	7024653	50
23		Orange	7024656	50

Flat ribbon deposits of thick pastes, sealants & epoxies.



TIP SHIELDS				
Size	Color		Part #	Qty/Box
3cc		Red	7017715	10
5cc to 70cc		Black	7017717	10

Reusable tip shields for light-sensitive and UV-cure adhesives. Fits over dispensing tip hub.



POLYETHYLENE NOZZLES						
Gauge	ID		length		Part #	Qty/Bag
	mm	inch	mm	inch		
0.318	0.125	6.35	2.5	7018555	10	
0.157	0.062	6.35	2.5	7018557	10	
0.157	0.062	10.6	4.0	7018559	10	
0.08	0.031	10.6	4.0	7018561	10	

Polyethylene nozzles thread into all cartridge sizes and 725 Series and 736HPA-NV valves. 1/4 NPT (6.35 mm) thread.



METAL NOZZLES				
Gauge	ID		Part #	Qty/Bag
	mm	inch		
7	3.8	0.150	7014850	1
8	3.4	0.135	7014851	1
10	2.7	0.106	7014848	1
12	2.2	0.085	7014842	1
14	1.6	0.063	7014844	1
16	1.2	0.047	7014846	1

Metal nozzles thread into all cartridge sizes to fit 725 Series and 736HPA-NV valves. 38.1 mm (1 1/2") long metal nozzles with 1/4 NPT.



Precision Dispensing Tips

Applications	DISPENSING TIPS						
	Tapered	Stainless Steel	PTFE-Lined	Flexible	MicroDot Ceramic	MicroDot Stainless Steel	Precision Nozzle
Very Low Viscosity Fluids	X	●	●	●	●	●	●
Particle-Filled Pastes	●	●	▲	X	●	▲	●
Microdot Deposits	X	●	▲	●	●	●	●
Fluid is Reactive to Metal	●	X	●	●	●	X	X
Depositing in Recesses	▲	●	●	▲	●	●	X
Spreading/Smearing	●	▲	●	▲	●	●	●
Fast-Curing Glues	●	▲	●	●	▲	▲	X
Beading, Striping	●	●	●	▲	●	▲	●
Easily Scratched Substrates	●	▲	●	●	●	▲	▲
Fluids							
Adhesives	●	●	●	●	●	●	●
Anaerobics	●	▲	●	▲	●	X	X
Conformal Coatings	●	▲	▲	X	▲	▲	●
Cyanoacrylates	●	▲	●	●	●	▲	▲
Gel Cyanoacrylates	●	▲	●	▲	●	▲	▲
Epoxies	●	●	●	X	●	●	●
Greases	●	●	●	X	●	●	●
Light-Cure Adhesives	●	▲*	▲*	X	▲	●	●
Oils	●	●	●	▲	●	●	●
Paints	●	●	●	X	●	●	●
Sealants	●	▲	▲	X	●	●	●
Silver Epoxy	X	▲+	X	X	●	▲	●
Solder Paste/Braze Pastes	●	●	▲	X	●	▲	●
Solder Masks	●	●	▲	X	●	●	●
Solvents	X	●	●	●	●	●	●
UV-Cure Adhesives	●**	▲*	▲*	▲	▲	●	●

*OK if used with tip shield, part #7017715 or 7017717.

+Chamfered tips are recommended for best results.

**Standard tapered tips are recommended for best results.

Key

- Recommended
- ▲ Satisfactory
- X Do not use



World Leader in Precision Fluid Dispensing

Nordson EFD's worldwide network of experienced product application specialists are available to discuss your dispensing project and recommend a system that meets your technical requirements and budget.

Here are just a few things our customers have to say about working with us:

"We're producing better-looking parts in half the time."

– ECM Motor Co.

"Our product is critical. That's why our choice is EFD equipment."

– Ethicon Endo Surgery

"Your system has several benefits compared to what we used before. We're talking about 75% less consumption [of oil]."

– Gestamp Aveiro

"The quality of their product, as well as their knowledge and support, have been nothing short of excellent."

– Lorik Tool & Automation Inc.

"Better control means over \$50,000 in fluid savings annually."

– Mitsubishi

"It's not complicated. You set it up and it works."

– Texas Instruments

"Applications support from Nordson EFD has been exceptional. They are quick to respond & give us the information needed."

– Preh Ima Automation

"The quality of the packages that we put our products in matters. That's why we use EFD syringes and cartridges."

– Dymax



For Nordson EFD sales and service in over 40 countries, contact Nordson EFD or go to www.nordsonefd.com.

Global

800-556-3484; +1-401-431-7000
info@nordsonefd.com

Europe

00800 7001 7001
infoefd.europe@nordsonefd.com

Asia

China: +86 (21) 3866 9006; china@nordsonefd.com
India: +91 80 4021 3600; india@nordsonefd.com
Japan: +81 03 5762 2760; japan@nordsonefd.com
Korea: +82-31-736-8321; korea@nordsonefd.com
SEAsia: +65 6796 9522; sin-mal@nordsonefd.com

Viton is a trademark of E.I. DuPont.
©2023 Nordson Corporation 7014626 v022123